

信号区

用户按键

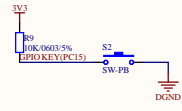

USART3板级通信接口

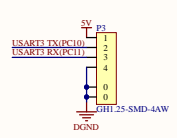

光电扩展板接口

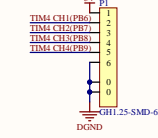

舵机扩展板接口

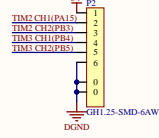

联合调试接口

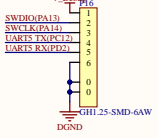

UART5调试接口

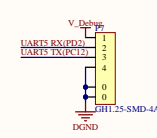

SWD调试接口

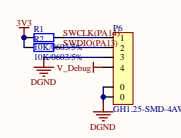

USART1算法设备接口

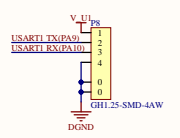

输出电压选择

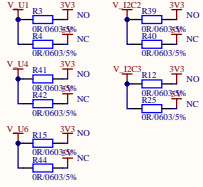

状态指示灯

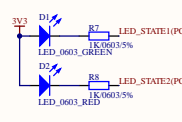

ADC接口

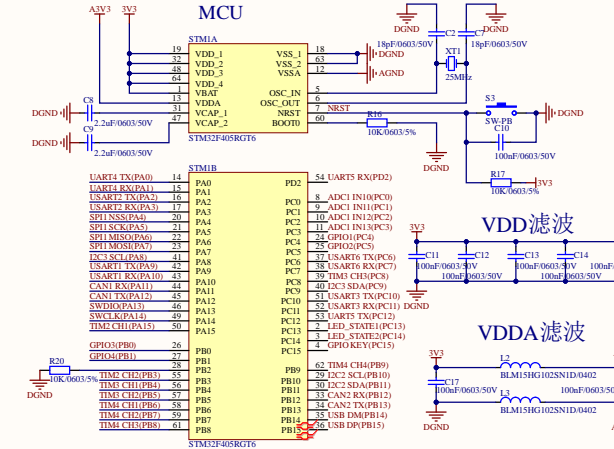
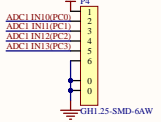

CAN1 Transceiver

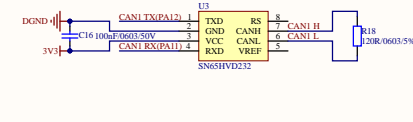

CAN扩展板接口

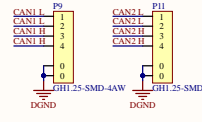

固定孔位



WS2812显示

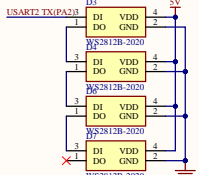

SPI接口

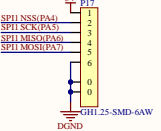

VDD滤波

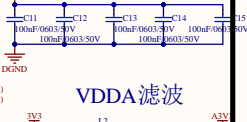

VDDA滤波

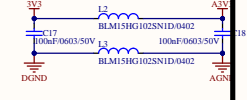

CAN2 Transceiver

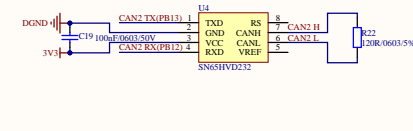

USART6裁判系统接口

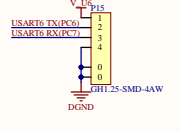

USART2/遥控接口

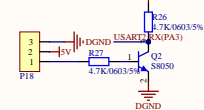

电磁阀扩展板接口

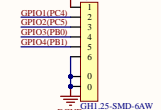

UART4陀螺仪接口

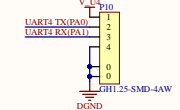

I2C2接口

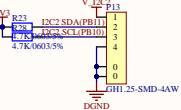

I2C3接口

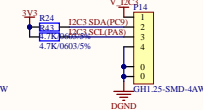

USB Terminator

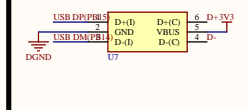

USB接口

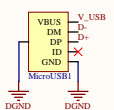

舵机接口

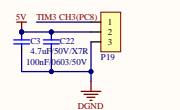

电源区

24V IN



24V OUT



Surge Stopper

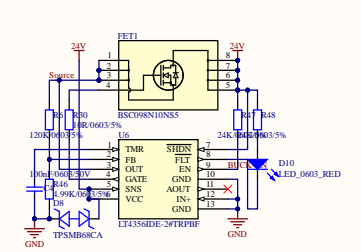

Dual Channel BUCK

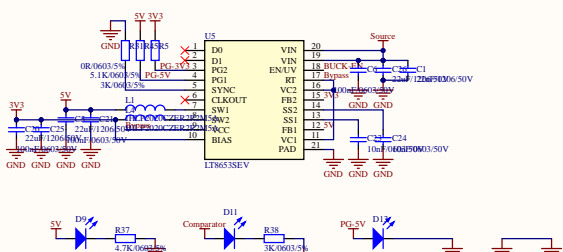

调试&USB输入保护

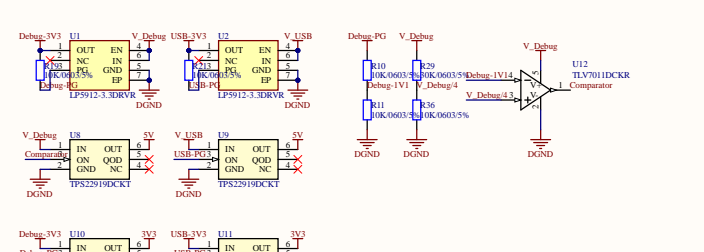

Title				HWSD-MAIN for Robotics			
Size		Number		Revision		V2.0	
A2							
Date: 4/27/2021				Sheet of: 1			
File: C:\Users\HWSD-MC_SCH\SubDoc				Drawn By: ASR-Crash			